

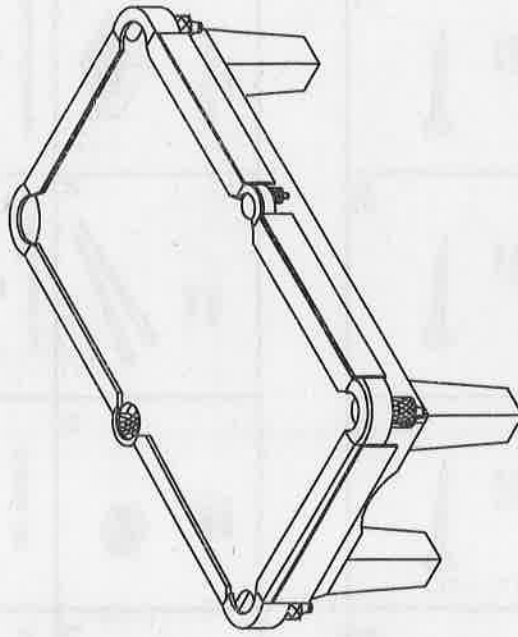





















SLATE POOL TABLE

ASSEMBLY INSTRUCTIONS



A	 RAILS 6PCS	B	 LONG SIDE PANELS 2pcs	C	 SHORT SIDE PANELS 2pcs	D	 SHORT SUPPORT 2PCS
E	 SLATE BOTTOM BOARD 6PCS	F	 SLATE BOTTOM BOARD 2PCS	G	 SLATE BOTTOM BOARD 2PCS	H	 LEGS 4pcs
I	 BALL CATCHER 4PCS	J	 BALL CATCHER 2PCS	K	 CLOTHS 1PC	L	 SLATE PLAYFIELD 1 SET
M	 Billiard ball 1 set	N	 Cue 4 pcs	O	 Chalk 1 box	P	 triangle 1 pc

#1	 P4*30 30PCS	#2	 P4*15 60PCS	#3	 P4*12 30PCS	#4	 P4*45 36PCS
	 1 pc						

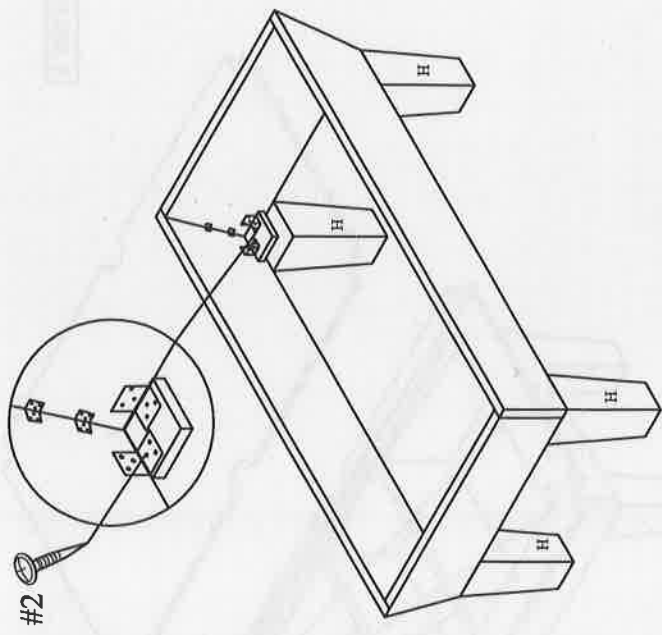

STEP 1

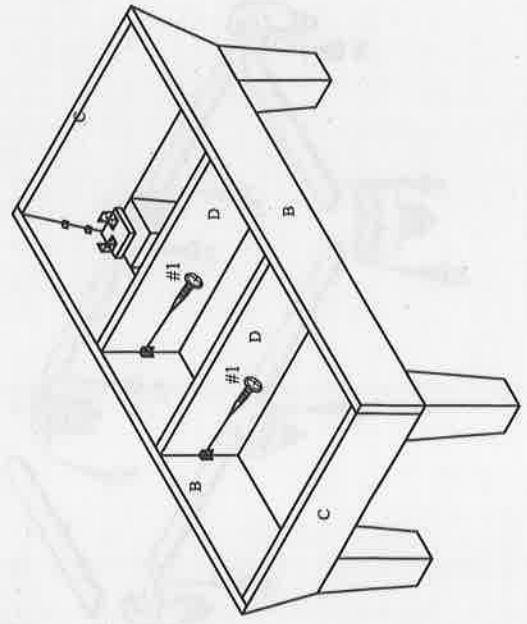

STEP 2

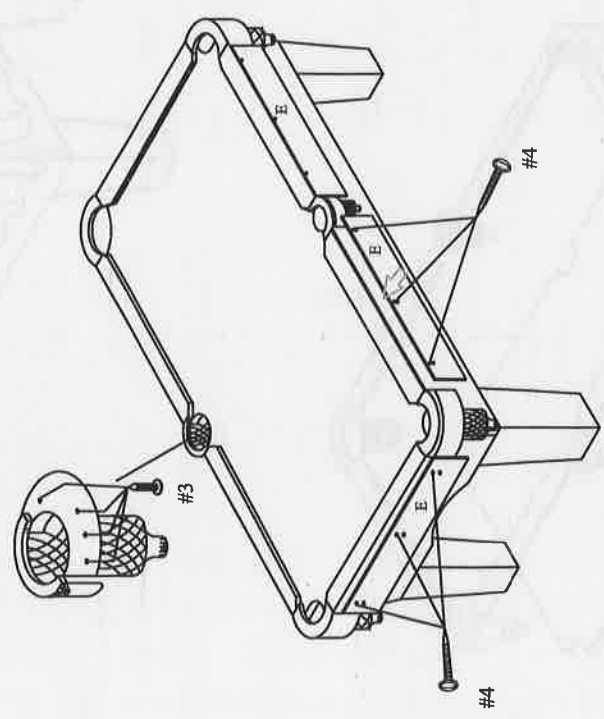

STEP 7

STEP 3

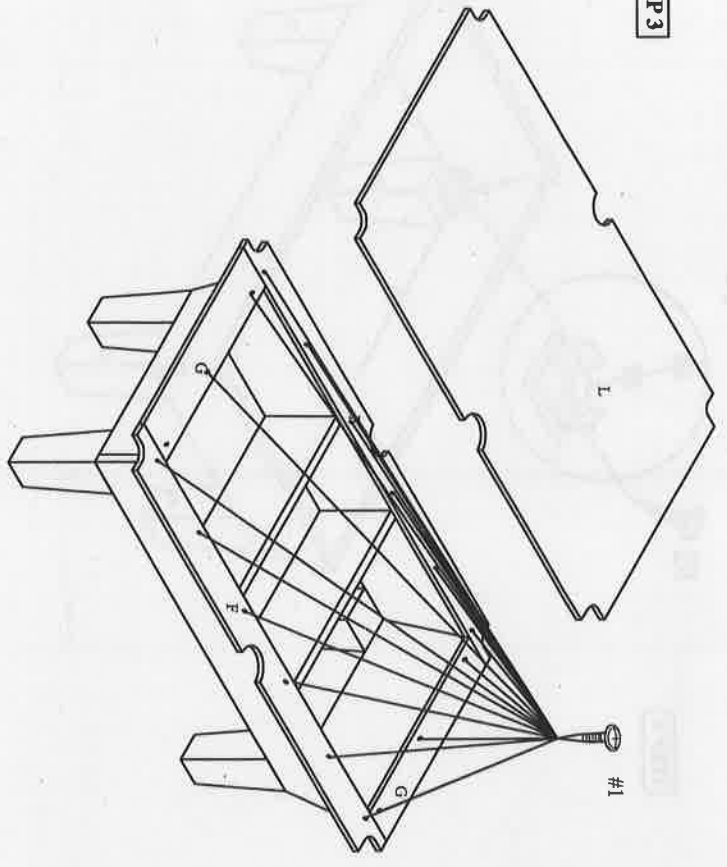

STEP 5

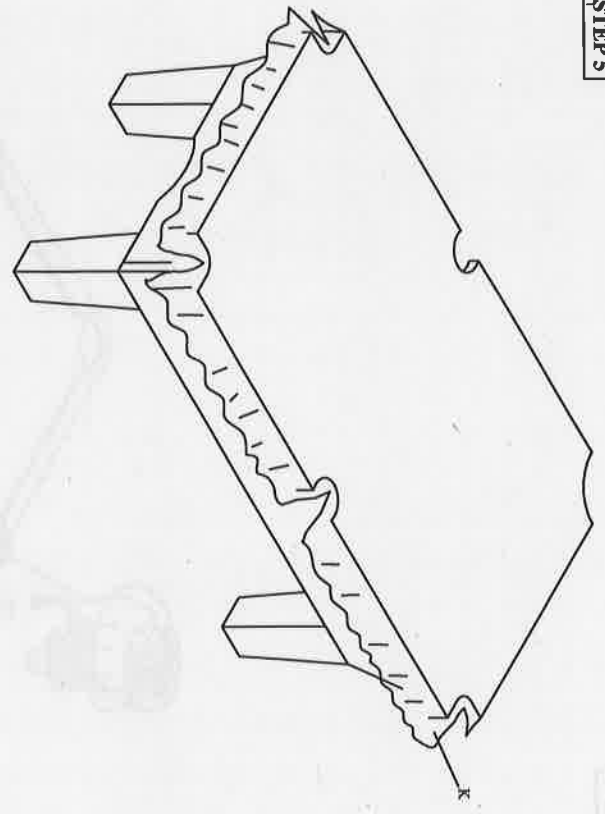

STEP 6

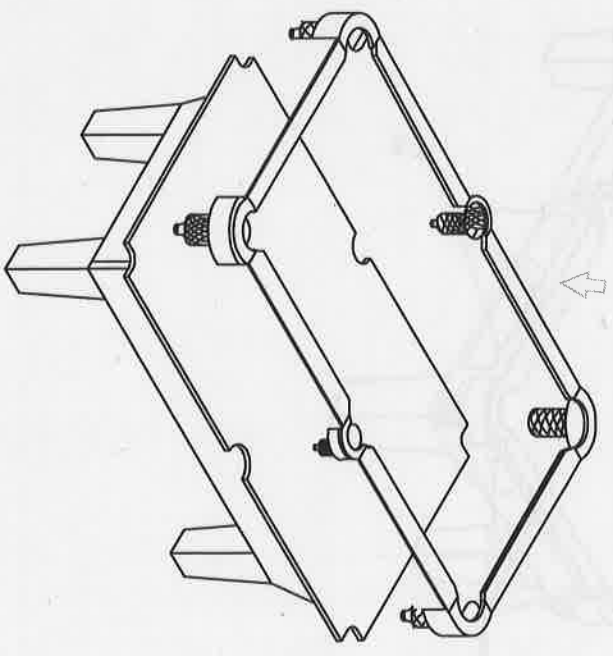

STEP 4

